

### Features

- Micropower operation
- Operation with magnetic field of either north or south pole (omnipolar)
- 2.5V to 5.5V battery operation
- Chopper stabilized
  - Superior temperature stability
  - Extremely Low Switch-Point Drift
  - Insensitive to Physical Stress
- Good RF noise immunity
- -40°C to 85°C operating temperature
- ESD (HBM) > 5KV
- DFN2015-6 and DFN3020-6: Available in "Green" Molding Compound (No Br, Sb)
- Lead Free Finish/ RoHS Compliant (Note 1)

### General Description

AH1822 is comprised of two Hall effect plates and an open-drain output driver, mainly designed for battery-operation, hand-held equipment (such as Cellular and Cordless Phone, PDA). The total power consumption in normal operation is typically 24μW with a 3V power source.

Either north or south pole of sufficient strength will turn the output on. The output will be turned off under no magnetic field. While the magnetic flux density (**B**) is larger than operating point (**Bop**), the output will be turned on (low), the output is held until **B** is lower than release point (**Brp**), then turned off.

### Applications

- Cover switch in clam-shell cellular phones
- Cover switch in Notebook PC/PDA
- Contact-less switch in consumer products

### Ordering Information

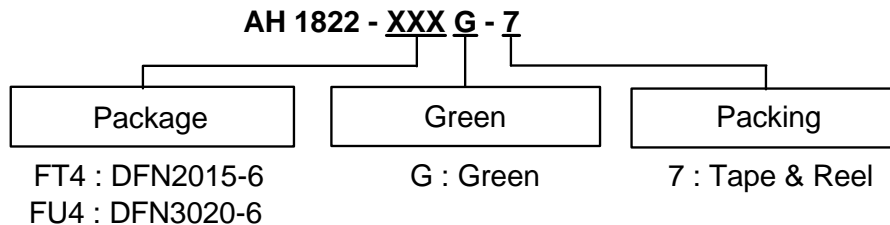

Device	Package Code	Packaging (Note 2)	7" Tape and Reel	
			Quantity	Part Number Suffix
AH1822-FT4G-7	FT4	DFN2015H4-6	3000/Tape & Reel	-7
AH1822-FU4G-7	FU4	DFN3020H4-6	3000/Tape & Reel	-7

Notes: 1. EU Directive 2002/95/EC (RoHS). All applicable RoHS exemptions applied, see *EU Directive 2002/95/EC Annex Notes*.  
 2. Pad layout as shown on Diodes Inc. suggested pad layout document AP02001, which can be found on our website at <http://www.diodes.com/datasheets/ap02001.pdf>.

### Pin Assignments

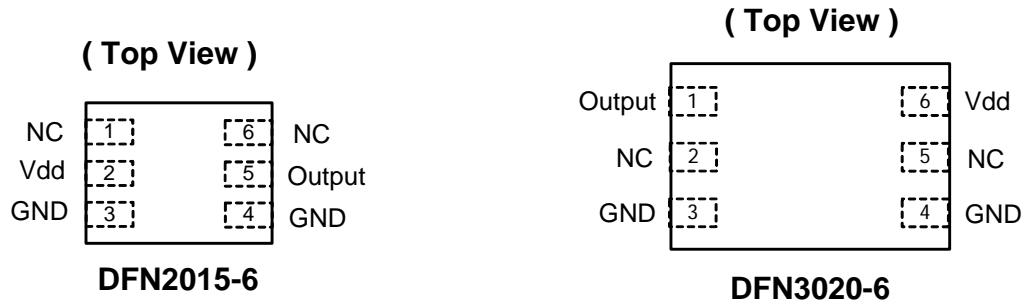

Notes: 3. NC is "No Connection" which is recommended to be tied to ground.

### Pin Descriptions

Pin Name	P/I/O	Description
Vdd	P/I	Power Supply Input
GND	P/I	Ground
Output	O	Output Pin
NC	NC	No Connected

### Block Diagram

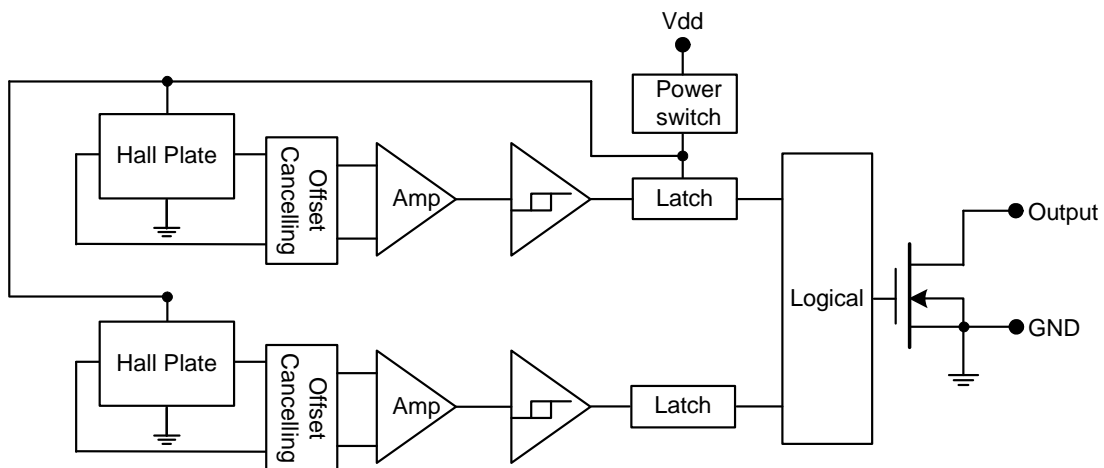

### Typical Circuit

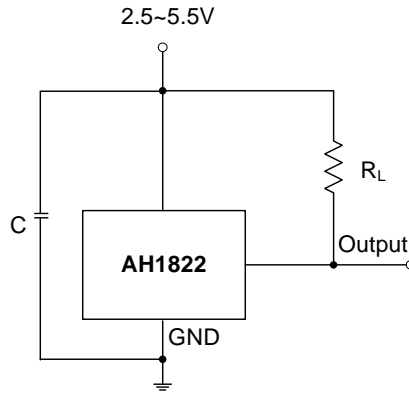

Notes: 4. C is for power stabilization and to strengthen the noise immunity, the recommended capacitance is 10nF~100nF.  
 $R_L$  is the pull-up resistor, the recommended resistance is 10K $\Omega$ ~100K $\Omega$ .

### Absolute Maximum Ratings (at $T_A = 25^\circ\text{C}$ )

Symbol	Characteristics	Values	Unit
V <sub>dd</sub>	Supply voltage	7	V
B	Magnetic flux density	Unlimited	
T <sub>ST</sub>	Storage Temperature Range	-65 to +150	°C
P <sub>D</sub>	Package Power Dissipation	230	mW
T <sub>J</sub>	Maximum Junction Temperature	150	°C

### Recommended Operating Conditions

Symbol	Parameter	Conditions	Rating	Unit
V <sub>dd</sub>	Supply Voltage	Operating	2.5~5.5	V
T <sub>A</sub>	Operating Temperature Range	Operating	-40 to +85	°C

### Electrical Characteristics (TA = +25°C, Vdd = 3V; unless otherwise specified)

Symbol	Characteristic	Conditions	Min	Typ.	Max	Unit
Vout	Output On Voltage	Iout=1mA	—	0.1	0.3	V
Ioff	Output Leakage Current	Vout=5.5V, Output off	—	<0.1	1	μA
Idd(en)	Supply Current	Chip enable, TA= 25°C, Vdd = 3V	—	3	6	mA
Idd(en)		Chip enable, TA= -40~85°C, Vdd = 2.5~5.5V	—	3	10	mA
Idd(dis)		Chip disable, TA= 25°C, Vdd = 3V	—	5	10	μA
Idd(dis)		Chip disable, TA= -40~85°C, Vdd = 2.5~5.5V	—	5	18	μA
Idd(avg)		Average supply current, TA= 25°C, Vdd = 3V	—	8	16	μA
Idd(avg)		Average supply current, TA= -40~85°C, Vdd = 2.5~5.5V	—	8	28	μA
Fc		Chopping Frequency	For design information only	—	300	—
Tawake	Awake Time	(Note 5)	—	75	150	μs
Tperiod	Period	(Note 5)	—	75	150	ms
D.C.	Duty Cycle		—	0.1	—	%

Notes: 5. When power is initially on, the operating Vdd (2.5V to 5.5V) must be applied to be guaranteed for the output sampling. The output state is valid after the second operating phase (typical 150ms).

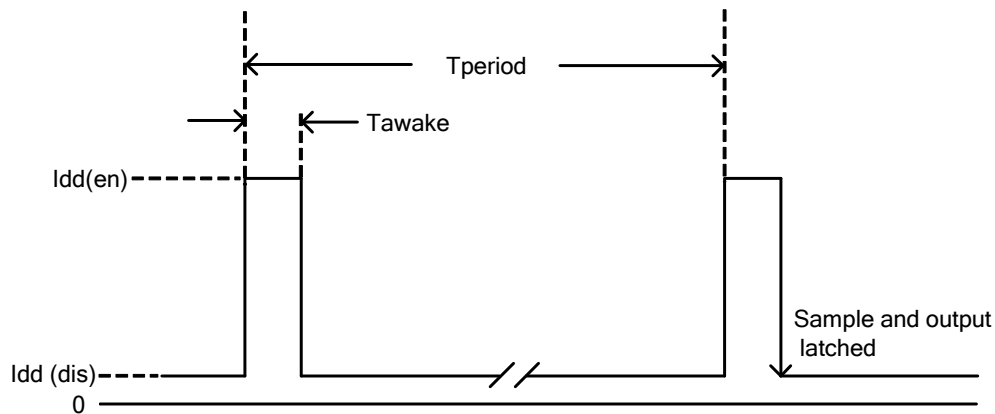

### Magnetic Characteristics (TA=25°C, Vdd=3V, Note 6, 7)

(1mT=10 Gauss)

Symbol	Characteristic	Min	Typ.	Max	Unit
Bops(south pole to brand side)	Operate Point	-	28	55	Gauss
Bopn(north pole to brand side)		-55	-28	-	
Brps(south pole to brand side)	Release Point	10	20	-	
Brpn(north pole to brand side)		-	-20	-10	
Bhy( Bopx - Brpx )	Hysteresis	5	8	-	

Notes: 6. Typical data is at Ta = 25°C, Vdd = 3V, and for design information only.  
7. Operating point and release point will vary with supply voltage and operating temperature.

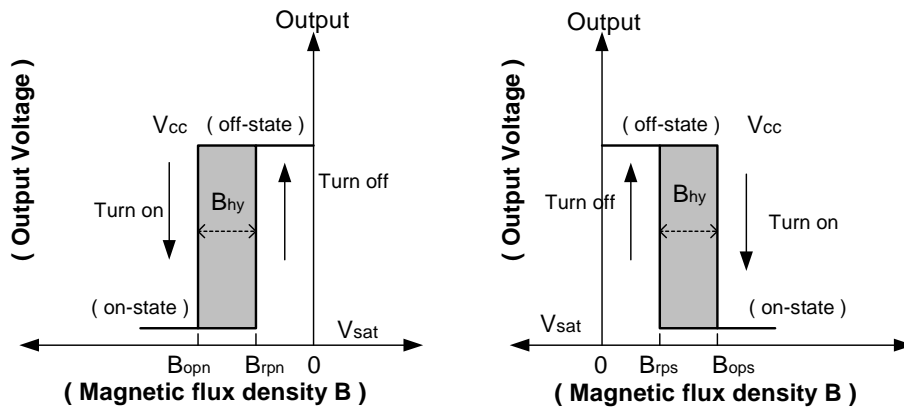

### Performance Characteristics

TA (°C)	25	50	60	70	80	85	90	100	110	120	130	140	150
PD (mW)	230	184	166	147	129	120	110	92	74	55	37	18	0

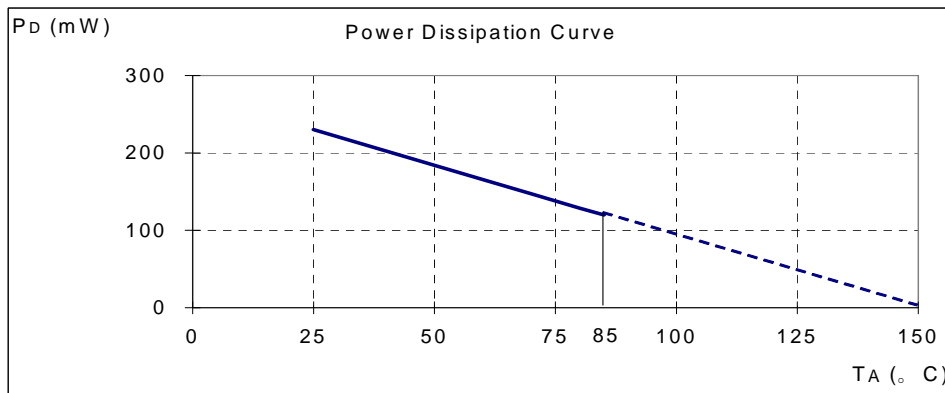

### Marking Information

(1) DFN2015-6

( Top View )

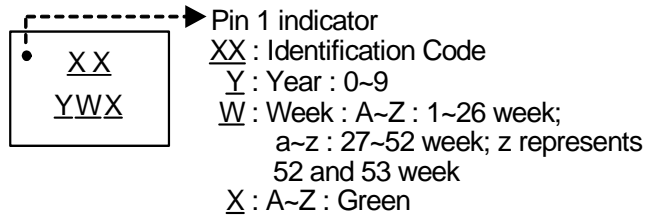

Part Number	Package	Identification Code
AH1822	DFN2015-6	K7

(2) DFN3020-6

( Top View )

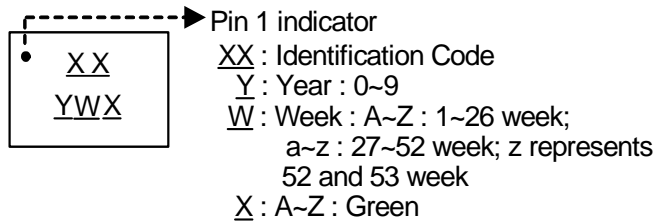

Part Number	Package	Identification Code
AH1822	DFN3020-6	K8

**Package Information (All Dimensions in mm)**

**(1) Package type: DFN2015-6**

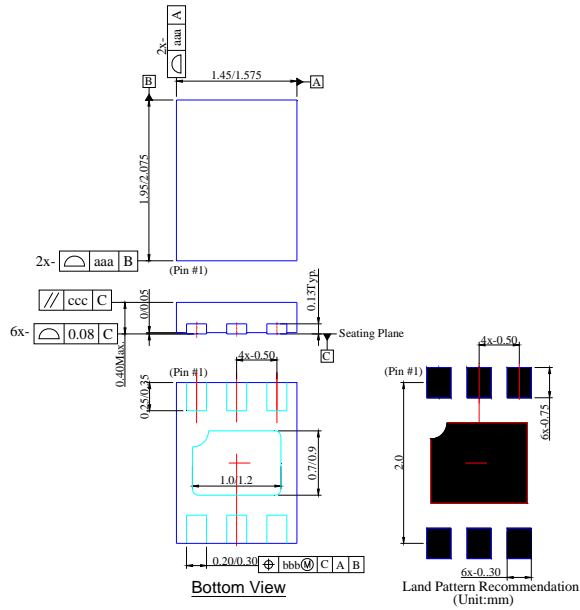

**(2) Package type: DFN3020-6**

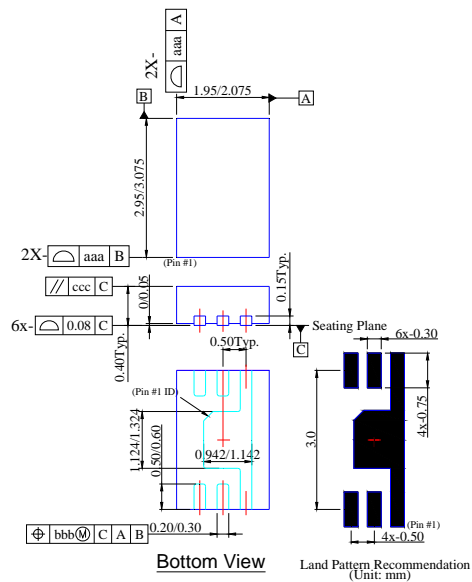

**Taping Orientation**

(1) DFN2015-6

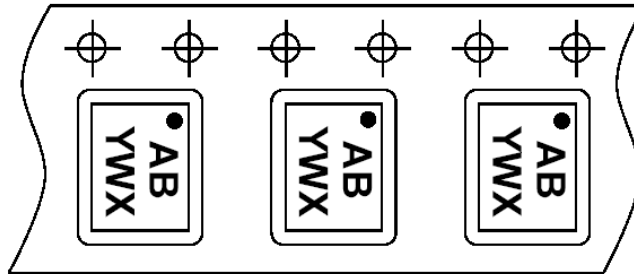

(2) DFN3020-6

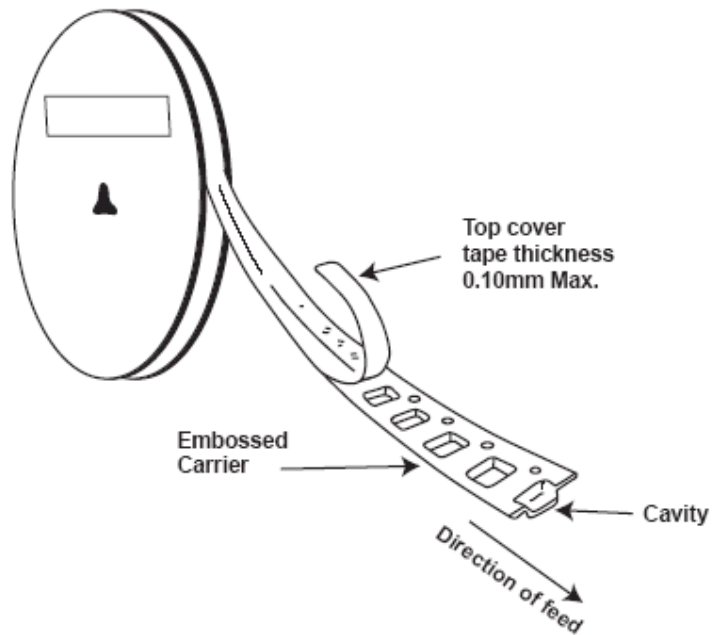
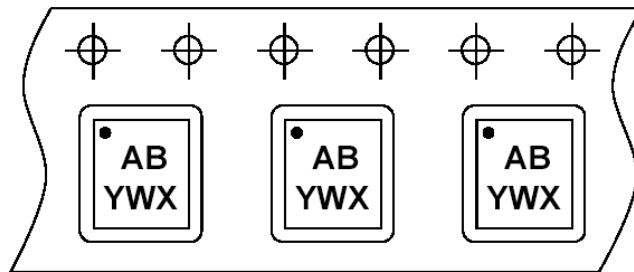

Notes: 8. The taping orientation of the other package type can be found on our website at <http://www.diodes.com/datasheets/ap02007.pdf>.



### IMPORTANT NOTICE

Diodes Incorporated and its subsidiaries reserve the right to make modifications, enhancements, improvements, corrections or other changes without further notice to any product herein. Diodes Incorporated does not assume any liability arising out of the application or use of any product described herein; neither does it convey any license under its patent rights, nor the rights of others. The user of products in such applications shall assume all risks of such use and will agree to hold Diodes Incorporated and all the companies whose products are represented on our website, harmless against all damages.

### LIFE SUPPORT

Diodes Incorporated products are not authorized for use as critical components in life support devices or systems without the expressed written approval of the President of Diodes Incorporated.